

User Manual

CO₂ Sampling Data Logger NEMA4



Models

CM-0052	CM-0152	CM-0154
CM-0132	CM-0153	CM-0155

Table of Contents

MODELS.....	1
WELCOME.....	3
IMPORTANT SAFEGUARDS	4
PACKAGE CONTENTS.....	5
OPTIONAL ACCESSORIES	5
GASLAB® SOFTWARE.....	5
MINIMUM SYSTEM REQUIREMENTS.....	5
QUICK START GUIDE.....	7
POWER SOURCE.....	7
OUTPUTS AND CABLE LEGEND	7
SETUP	8
<i>Data Logging Configuration.....</i>	<i>8</i>
POWERING THE UNIT	9
LCD DISPLAY (IF APPLICABLE)	9
USAGE (PUMP ONLY).....	9
<i>Closed Loop Operation.....</i>	<i>9</i>
<i>Open Loop with Environmental Exhaust</i>	<i>9</i>
THEORY OF OPERATION	10
<i>0-1% and 0-30% Units Only.....</i>	<i>10</i>
CALIBRATION	11
<i>0-1% or 0-30% Sampling Unit with Data Logging.....</i>	<i>11</i>
CALIBRATION PROCEDURE.....	12
<i>0-5%, 65%, 100% Sampling Unit with or without Data Logging.....</i>	<i>12</i>
<i>Zero or Fresh Air Calibration</i>	<i>13</i>
<i>High-Concentration Calibration</i>	<i>13</i>
TROUBLESHOOTING GUIDE	13
DEVICE SPECIFICATIONS	14
SUPPORT	15
WARRANTY.....	15
LIABILITY.....	15
RETURNS	15
CONTACT US	16

Welcome

Thank you for purchasing our meter. CO2Meter, Inc. is a Florida based business specializing in the design and manufacturing of gas detection and monitoring devices – mainly CO2. Our approach is one based in the science of gas and how best to accurately and repeatedly measure that gas for the end users purposes. Our business partners in agriculture, HVAC, science, safety, research, pharmaceuticals, beverage, and other fields find our devices to be highly accurate and cost effective.

We approach each customer's application as a unique opportunity to understand, educate, and provide product solutions that meet the customers' needs while exceeding their expectations for reliability and service. Our continued product innovation in combination with our "customer first" focus allows CO2Meter, Inc. to continue to provide solutions for the future.

Based in Ormond Beach, FL, CO2Meter, Inc. is committed to the success of our customers; the health, welfare, and prosperity of our talented employees; and the continued development of our local community.

CO2Meter, Inc. appreciates your business and looks forward to working with you and your team in the future.

Please take some time to read through this manual in order to become familiar with the meter. Also, please pay special attention to the important safeguards shown on the next page.

WARNING!

Install GasLab® software before connecting your CO2Meter product(s) to your computer. Failure to do so may affect the ability for GasLab® to detect your meter/sensor. If this happens, please follow the instructions shown in the TroubleShooting Guide of this manual.

Important Safeguards

To reduce the risk of fire, electrical shock and/or injury to persons, basic safety precautions should always be followed when using electrical appliances, including the following:

1. **READ ALL INSTRUCTIONS BEFORE USING THIS METER.**
2. **INSTALL GasLab® SOFTWARE BEFORE CONNECTING METER TO A COMPUTER.**
3. Use only the included power supply to operate this meter.
4. Make sure that the tubes are securely attached to the meter before sampling a closed environment (CM-0045-NM-SP model only).
5. Do not operate with an obstructed sample path (CM-0045-NM-SP model only).
6. Do not operate this meter if the enclosure is opened.
7. Do not operate the device if it is malfunctioning.

SAVE THESE INSTRUCTIONS!

Package Contents

Please verify that your package contains the following items before using the meter:

All units:

- (1) NEMA Sampling Meter
- (1) 6-foot USB Cable
- (1) M12, 12-positions 5M cable
- (1) Fitting, tubing & filter kit
- (1) User manual



Figure 1

Optional Accessories

If not included, you can purchase an Extreme Moisture filter separately. These filters are ideal for high-humidity environments to allow air flow while keeping humidity out. Use anywhere humidity is very high (> 95%). SKU #CM-0103.



GasLab® Software

IMPORTANT: MAKE SURE TO INSTALL SOFTWARE BEFORE CONNECTING YOUR METER TO YOUR COMPUTER

Minimum System Requirements

To utilize our free software, the computer must meet the following minimum requirements:

- 1GHz processor with 1GB RAM, 1GB free disk space (2GB free disk space for 64-bit systems).
- Windows XP*/7/8/8.1 with Microsoft .NET Framework 4.0** or later.
- On Intel-based Mac computers, GasLab® software can run using a Windows 7/8 virtual machine software such as *VMware Fusion®* or similar.

*Microsoft .NET is not supported on Media Center or Tablet editions.

**Installer will optionally install .NET Framework.

Visit www.co2meter.com/pages/downloads to download our complimentary GasLab® software to your computer. You can also download the GasLab®'s user manual in PDF from this page.

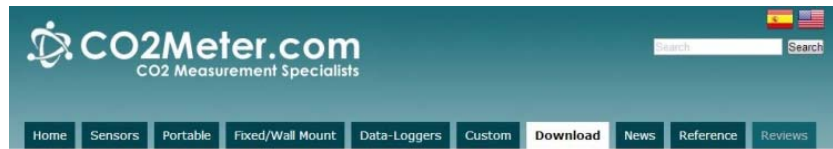

Please read the GasLab®'s user manual carefully to become more familiar with how the software works so that you can get the maximum benefit from this useful tool.

Install the GasLab® software first to ensure that the proper driver, necessary for the meter, is installed on your computer before connecting the meter.

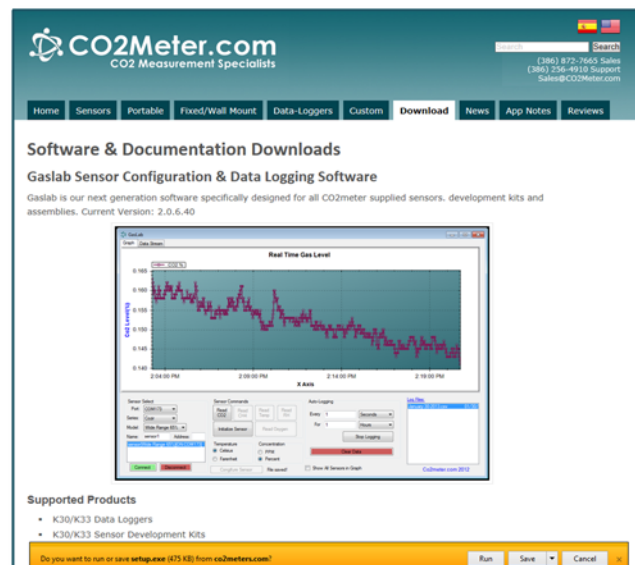
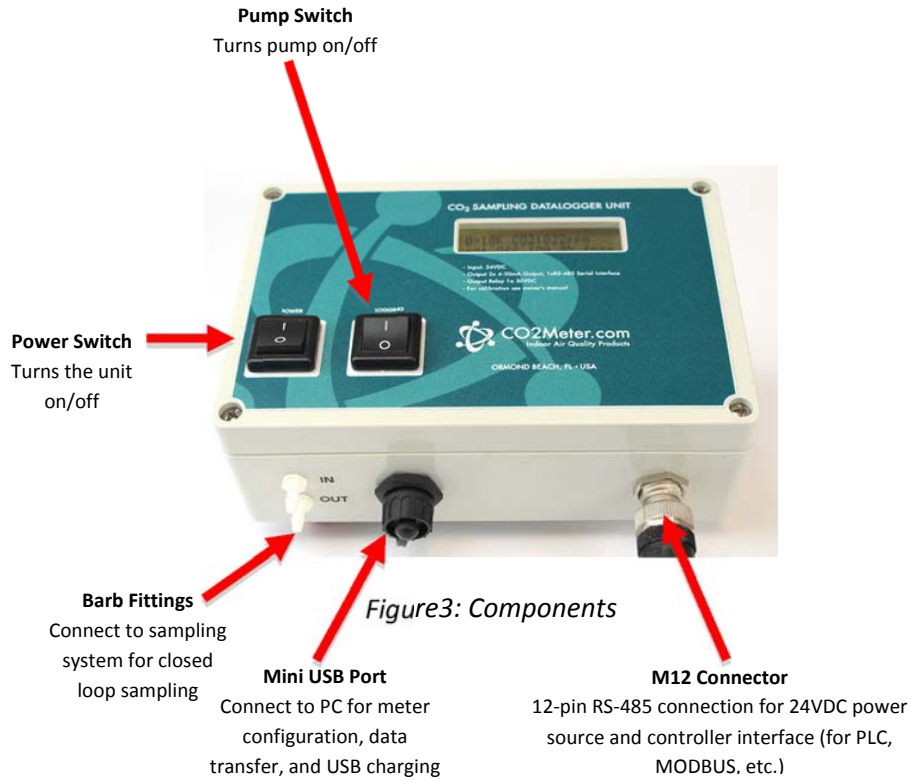

Figure 2: Install GasLab online (Internet Explorer 9 shown)

Quick Start Guide

Make sure you read through these instructions thoroughly before using your meter. This guide will help you familiarize with your meter in order to be as productive as you need to be in the least amount of time possible.



Power Source

These meters are powered by connecting to a suitable 24VDC power source. This is very convenient for permanent installations.

Outputs and Cable Legend

Pin #	Wire Color	Color Legend	Description
1	Brown		CO2 4-20mA-
2	Blue		N/O Relay
3	White		CO2 4-20mA+
4	Green		RS-485 Ground
5	Pink		N/C Relay
6	Yellow		COM Relay
7	Black		Power Ground
8	Grey		O2 4-20mA- *
9	Red		Voltage Input
10	Purple		O2 4-20mA- *
11	Pink/Grey		RS-485 B
12	Red/Blue		RS-485 A

Table 1: Cable legend. (* O2 models only)

These meters feature a 4-20mA linearly scaled output that matches the current CO2 concentration reading proportionally. In addition, it has a digital RS-485 interface for connection to a MODBUS network and one relay with 1A @ 30VDC for an external controller.

Setup

Our sampling device will require minimal setup since it is designed to be portable. The most important aspect of the setup involves connecting the sampling hoses and ensuring proper environmental setup. Figure above shows the labeled components of the unit, as referenced throughout the rest of this manual.

Data Logging Configuration

These meters feature an internal memory capable storing data when not attached to a personal computer. These units will allow you to simultaneously read and store CO2 concentration level data. Due to the nature of their design, these units should be connected to your personal computer first, before operation, to initialize and set the logging period, and real-time clock.

0-1%, 5%, 30%, 65%, 100% CO2 Sampling Data Loggers

Make sure the unit is powered with 24VDC using the RS-485 cable included. In order to initialize data logging functionality, the unit MUST be connected to the computer with data logging switched to *off*, and the GasLab® software started. Once the unit has been connected, click on the “Configure Sensor” button in the GasLab® interface, set the data logging interval and pump periods as desired.

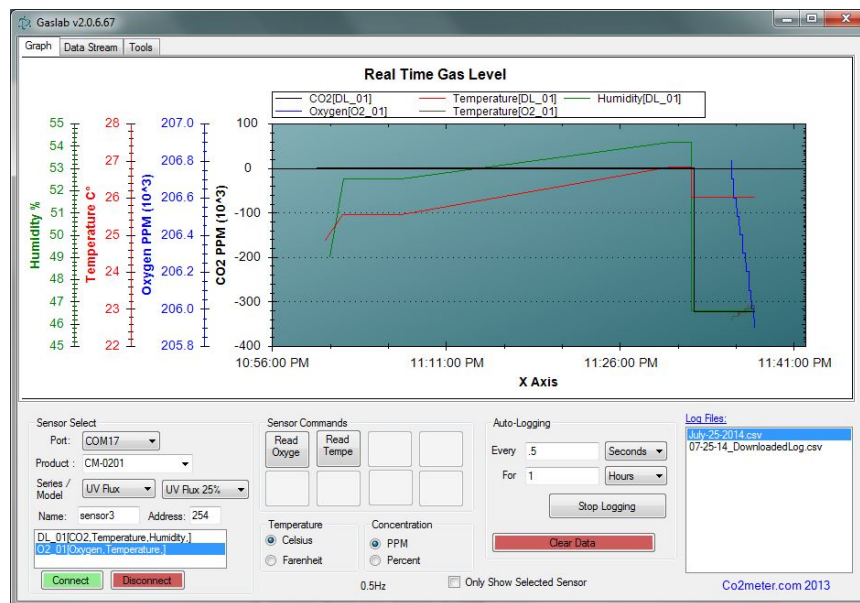

Figure 4: Collecting data in real time

Powering the Unit

These meters have a switch on the front dedicated to enabling/disabling data logging (right on Figure above) and another dedicated to powering the unit (left on Figure above). As long as the unit is connected to an appropriate power source and the power switch is in its ON position, the unit will be operating properly.

LCD Display (if applicable)

The Liquid Crystal Display (LCD) screen shows the following features:

- CO2 in parts-per-million (ppm) for 1% and 5% models
- CO2 in percentage format (##.##%) for 30%, 65%, 100%
- Logging On/Off
- Percentage of memory free

Usage (Pump only)

In order to use the unit, hoses/tubing must be attached to the inlet and outlet fittings on the front of the unit. The pump will draw air from the inlet in a vacuum configuration, push it through the sensing chamber, and exhaust the air out through the outlet.

Closed Loop Operation

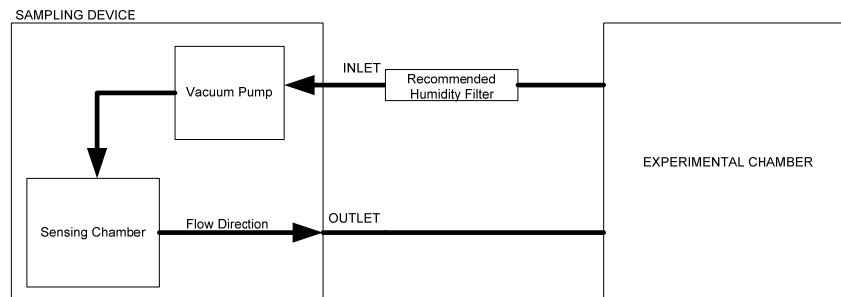

Figure 5: Closed loop sampling setup

Open Loop with Environmental Exhaust

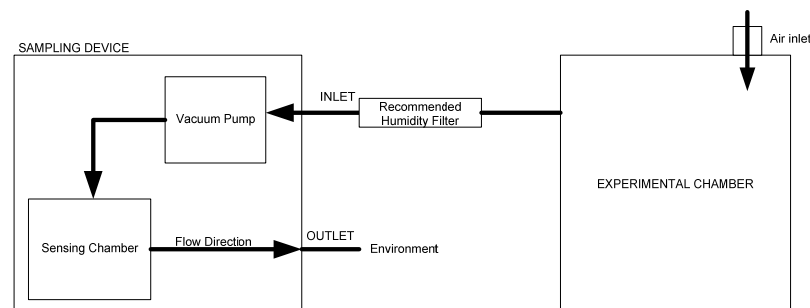

Figure 6: Opened loop sampling setup

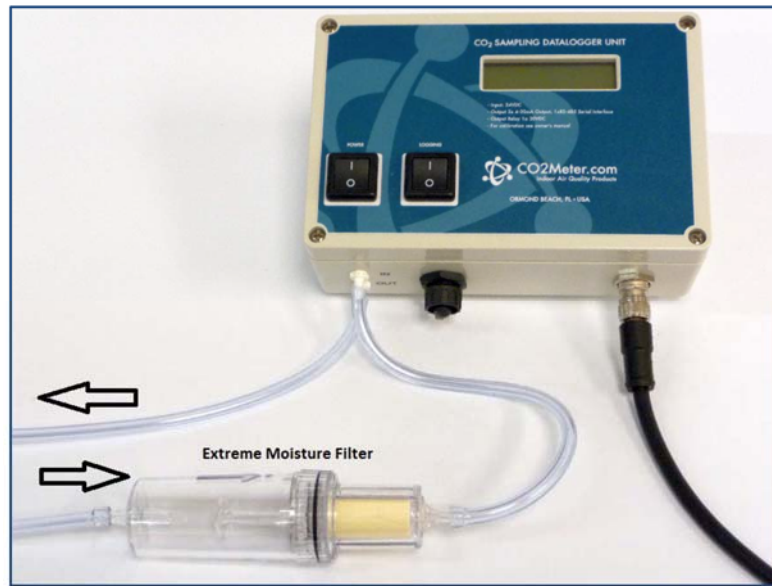

Figure 7: Filter Installation and Orientation.

We recommend installing the included humidity/particulate filter to ensure the sensing chamber and pump baffle stays clear and corrosion free.

Theory of Operation

The CO₂ sensor inside this device uses non-dispersive infrared technology to sense, as a function of transmitted light, the concentration of CO₂ in the air. It has been factory-calibrated to operate within the specified range and precision.

0-1% and 0-30% Units Only

The sensor uses an algorithm called Automatic Background Calibration (ABC) to continuously adjust the zero-point to ensure accuracy is maintained. This is required to compensate for sensor drift, which occurs normally on these units. The primary contributor to sensor drift is the normal and unavoidable aging of the infrared light source within the sensor.

The ABC algorithm allows the CO₂ sensor to dynamically shift its CO₂ reading by a constant. It works via storing the lowest CO₂ sample taken over the ABC period and assuming that this low value is equal to a known value (the target value). It then adjusts the output of the CO₂ reading by the delta between these values. This algorithm does not affect the linearization of the output signal.

For example, the ABC algorithm is enabled by default, with an ABC period of 180 hours, a target value of 400ppm, and a maximum delta of 30ppm. This operates under the principle that a CO₂ level in ambient outdoor air is 400ppm.

The sensor will keep track of the lowest CO₂ reading recorded over a period of 180 hours and then adjust the zero point based on the lowest CO₂ level recorded, up to 30ppm at a time, towards that value.

To ensure maximum accuracy, it is recommended to install the device in an environment that will routinely see this low value. Alternatively, the unit can be exposed to fresh air for a few minutes periodically, or set the ABC period to 0 sec. to perform a calibration as specified in the next section.

Calibration

The calibration process varies depending on the type of unit and whether it has optional data logging functionality or not. All units are factory-calibrated with multiple reference points of gas, and have been verified to be accurate within their specific functionality before shipment. However, if the unit is severely jolted or otherwise mechanically disturbed, the sensor can drift requiring recalibration. All calibration procedures follow a single-point calibration routine that effectively shifts the zero-point of the CO2 sensor.

Attach calibration gas to the unit and connect it to a personal computer. Open the calibration screen in the GasLab® software. Click the “Calibrate” button in the calibration tab for the desired gas, located in the “Configure Sensor” screen. As long as the gas concentration is stable, the unit should instantly reflect the calibrated value. This can be confirmed by watching the display. To see the calibration value in real time, click in the “Collect Real time” button to capture these values before opening the configuration screen.

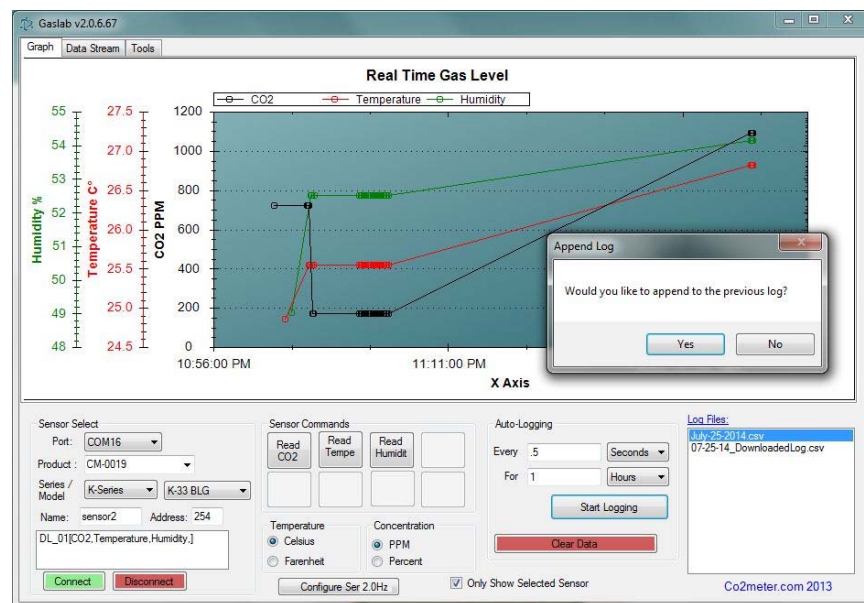

Figure 8: Real-time capture

0-1% or 0-30% Sampling Unit with Data Logging

Calibration can be performed using either 0% CO2 calibration gas (typically nitrogen, argon, etc.), or using a fresh source of air, assumed to be approximately 400ppm.

Open the calibration screen in the GasLab® software. Click the “Calibrate” button in the calibration tab, located in the “Configure Sensor” screen.

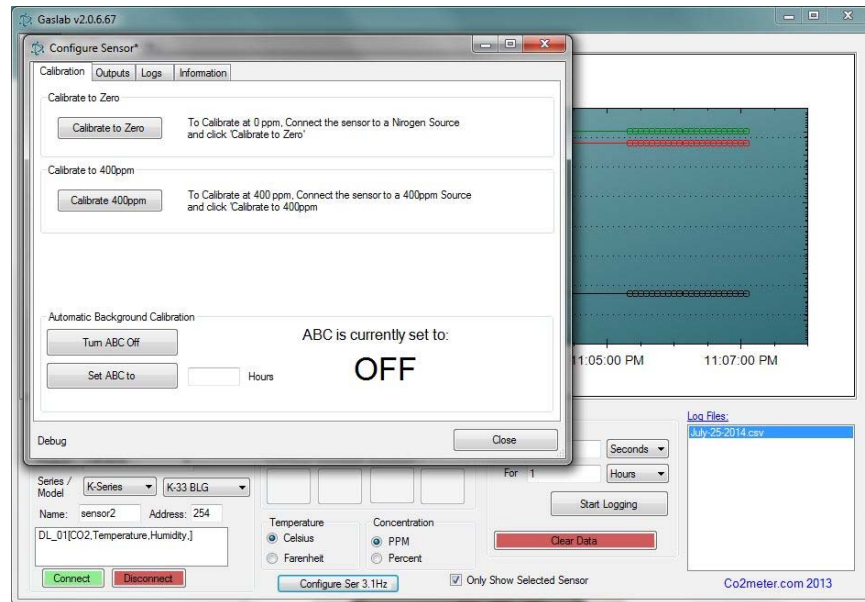

Figure 9: Data logger calibration screen for 0-1% CO2

Calibration Procedure

To calibrate your unit, follow these steps:

1. Expose the unit to ambient air (assumed to be at 400ppm) or connect it to a calibration gas bottle/cylinder (100% nitrogen or argon) with the appropriate demand regulator.
2. Wait 25 seconds to collect a sample. Write down this value as the “before” value.
3. Click the “Calibrate” button after selecting your calibration gas.
4. Wait 25 seconds again. This time, the unit will take a sample and use this data to adjust zero values. The displayed measurements will reflect the new calibration value (0 or 400ppm).
5. Disconnect the calibration gas and wait 25 seconds. The newly displayed data will now reflect the new sensor calibration. If the sensor is still operating outside of its specified range, repeat this procedure. When the readings vary too greatly, the calibration will silently fail and may need to be performed again.

0-5%, 65%, 100% Sampling Unit with or without Data Logging

These units do not feature Automatic Background Calibration (ABC) algorithm due to the CO2 scale they measure. To ensure the highest accuracy, we recommend calibrating these units with calibration gas (nitrogen for zero, or CO2), close to the concentration being measured. Alternatively, a 0% or ambient calibration can be performed.

To perform a calibration, attach the unit to your computer, power it and either expose it to atmosphere or supply it with your calibration gas, fed with a demand-based regulator.

Open the GasLab® software on your personal computer and click the “Configure Sensor” button. For data logging units, click the “Turn Pump on Continuously” button to ensure continuous flow. (To apply any changes, the unit has to power cycle).

Zero or Fresh Air Calibration

Apply gas and select the appropriate concentration in the screen shown in Figure above. Click the “Calibrate” button. The sensor reading should instantly reflect the calibration.

High-Concentration Calibration

Write down the original Zero Value before adjustment for future reference. Apply the desired concentration calibration gas; adjust the Zero Value in increments of 10 pressing scroll, put the right value of the calibration gas and click on the “Calibrate” button. Wait until the unit displays the correct concentration level, then close the window by clicking on the “Save” button.

NOTE: DO NOT ADJUST THE SPAN VALUE.

Troubleshooting guide

Symptom / Issue	Possible Cause / Resolution
Device/Sensor is not recognized by PC	Make sure the cable wires (see Table 1 on page 7) are connected to a suitable 24VDC power supply or that the USB cable is properly connected to a computer.
Device doesn't power ON	Perform resolution above and make sure that there is adequate power to the meter.
The GasLab® software doesn't start *1	Your software might be out of date. Update your software by either visiting our download webpage at http://www.co2meter.com/pages/downloads or by selecting the “Check for Updates” under the <i>Help</i> menu. Make sure your PC meets the minimum requirements.
Slow response	Check the air flow channels to make sure they are not obstructed.
Reading doesn't change	Calibration or recalibration needed.

*1For more troubleshooting tips on GasLab® please download the GasLab user manual at <http://www.co2meter.com/pages/downloads>.

Device Specifications

Measuring Range:	
1% CO2	0-10,000 ppm (0-1% vol.)
5%, 30%, 65%, 100% CO2	0-5%, 0-30%, 0-65%, or 100% vol., respectively
Accuracy (all ranges)	±0.5%, ±3% measured value
Power Supply:	
Maximum Voltage	30VDC
Minimum Voltage	18VDC
Power Consumption	~1Watt avg. (pump running)
Sensor Ratings:	
Life Expectancy	>15 years
Maintenance Interval	No maintenance required
Warm-up Time	<1 min (instant measurements)
Pump Characteristics:	
Maximum Flow (STP)	800 ml/min
Maximum Vacuum	52%
Maximum Pressure	600 mbar restart, 150 mbar continuous
Maximum System Pressure	~1 ATM
Outputs:	
Range	0-100% vol.
Output Value	4-20mA, linearly scaled
Relay	COM, NC, NO 1A @ 30VDC
RS-485	Modbus interface

Support

The quickest way to obtain technical support is via email. Please send all support inquiries to support@co2meter.com.

Please include a clear, concise definition of the problem and any relevant troubleshooting information or steps taken so far, so we can duplicate the problem and quickly respond to your inquiry.

Warranty

This meter comes with a 1YEAR (warranty period) limited manufacturer's warranty, starting from the date the meter was shipped to the buyer.

During this period of time, CO2Meter.com warrants our products to be free from defects in materials and workmanship when used for their intended purpose and agrees to fix or replace (at our discretion) any part or product that fails under normal use. To take advantage of this warranty, the product must be returned to CO2Meter.com at your expense. If, after examination, we determine the product is defective, we will repair or replace it at no additional cost to you.

This warranty does not cover any products that have been subjected to misuse, neglect, accident, modifications or repairs by you or by a third party. No employee or reseller of CO2Meter.com's products may alter this warranty verbally or in writing.

Liability

All liabilities under this agreement shall be limited to the actual cost of the product paid to CO2Meter.com. In no event shall CO2Meter.com be liable for any incidental or consequential damages, lost profits, loss of time, lost sales or loss or damage to data, injury to person or personal property or any other indirect damages as the result of use of our products.

Returns

If the product fails under normal use during the warranty period, a RMA (Return Material Authorization) number must be obtained from CO2Meter.com. After the item is received CO2Meter.com will repair or replace the item at our discretion.

To obtain a RMA number, call us at or email us at (386) 256-4910 support@co2meter.com. When requesting a RMA please provide reason for return and original order number.

If the product fails under normal use in the first 10 days of ownership, at our discretion we will email you a postage-paid UPS label to return the product at our expense.

If we determine that the product failed because of improper use (water damage, dropping, tampering, electrical damage etc.), or if it is beyond the warranty date, we will inform you of the cost to fix or replace the product.

Contact Us

We are here to help!

For information or technical support, please contact us.

 support@co2meter.com

 (386) 256-4910 (Technical Support)

 (386) 872-7665 (Sales)